



# FD6-130

## Drilling Unit

### ■ Specification

Hydraulic Pressure	20~25 kg/cm <sup>2</sup>
Drilling Capacity	φ 16(mild steel)
Flow Control Valve	FCC-G02-4
Max. Revolution/Minute	2,000rpm
Weight	32kg
Stroke	130mm
Cylinder Diameter	φ 80
Cylinder Area	Forward 43.2cm <sup>2</sup> , Backward 30.6cm <sup>2</sup>
Thrust Force	864kg(20kg/cm <sup>2</sup> )

### ■ Consumption Parts

Spindle Bearing	a. 32005x1, 6005Zx1, 32004x1, 6004Zx1
	b. 7005x2, 7004x2
Pulley Bearing	a. 6008Zx1, 51208x1 or 51108x1
	b.7008x2
O-Ring for Front Cover	UHS-58x1, P-58x1, USI-58-68-6x1, G-75x1
O-Ring for Piston	OSY-80x2, G-45x1
O-Ring for Rear Cover	P-30x1, PS-30x1, G75x1

- High rpm application is available, specify this requirement when placing order.
- Left side mounted fitting holes and flow control valve are available, specify this requirement with external electrical micro switch.
- The stopper is a safety device. It will shorten bearing life if applying pressure on stopper for too long.

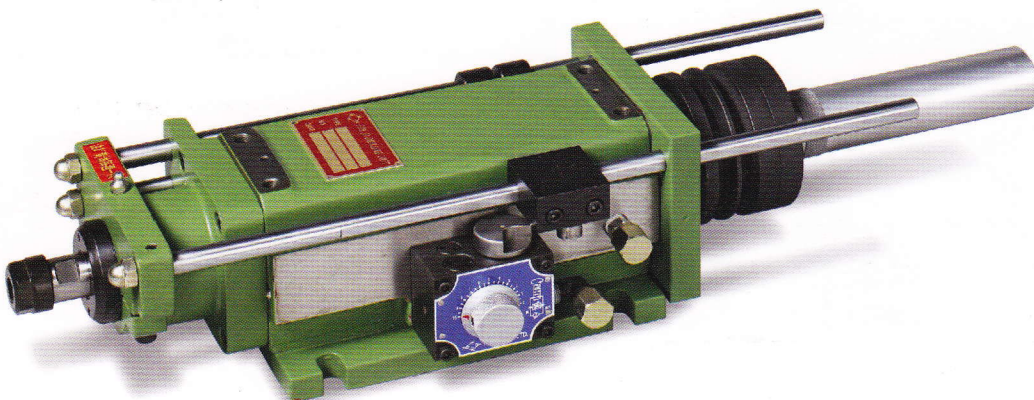
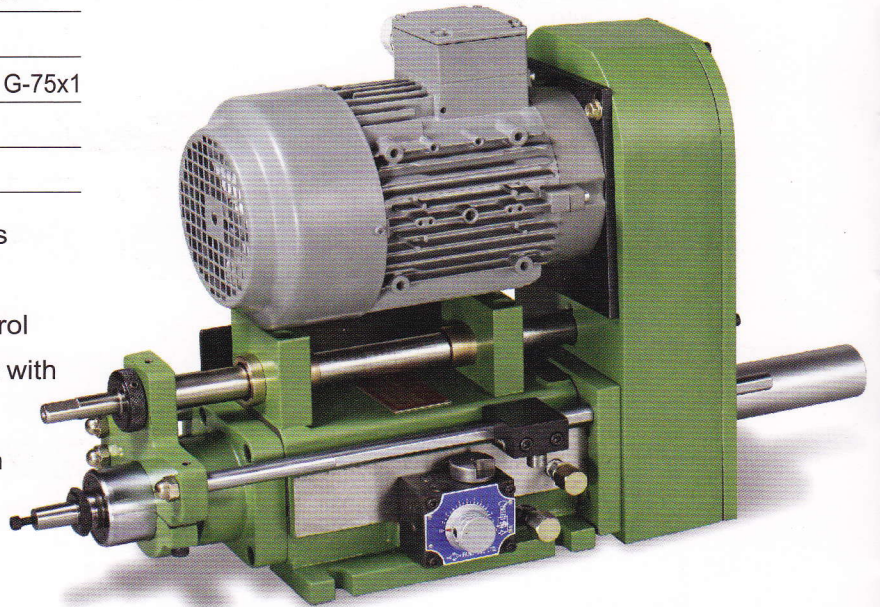



# FD6-130

# Drilling Unit

## ■ Dimensions

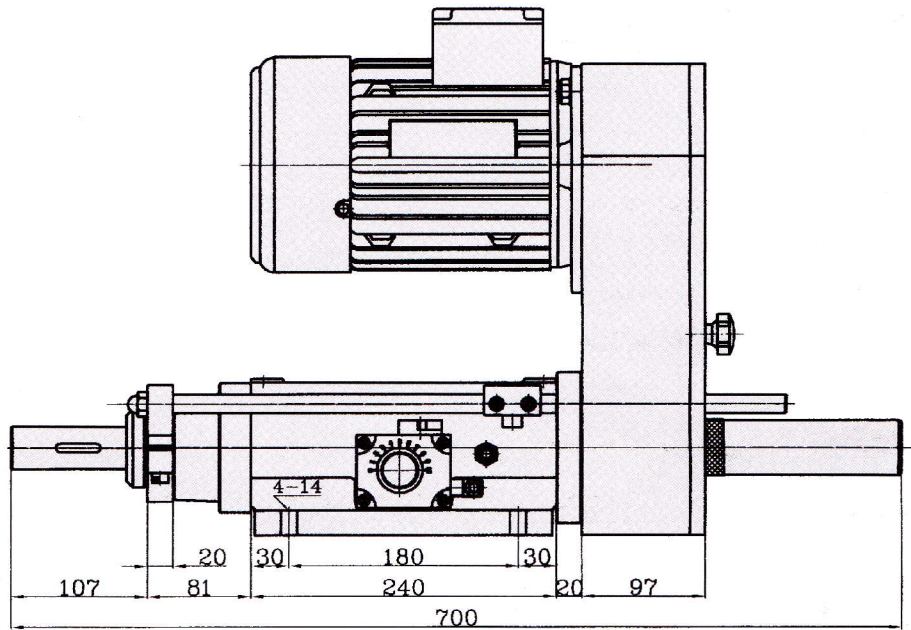
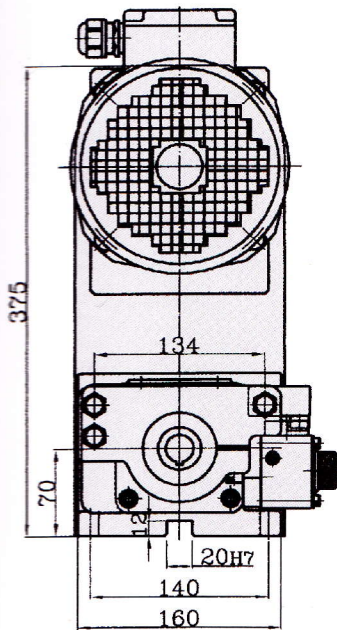

**FD6-130-JT6**

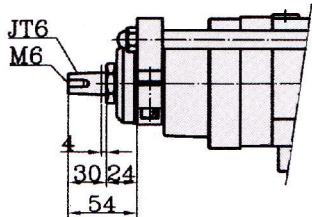

**FD6M-130-JT6 Multi**

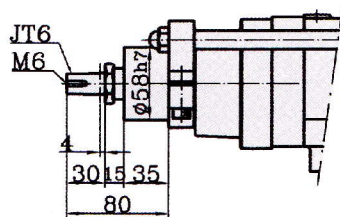

**FD6-130-ER25**

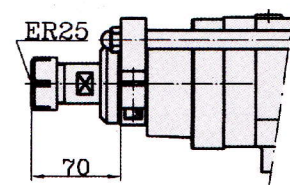

**FD6-130-ER20**

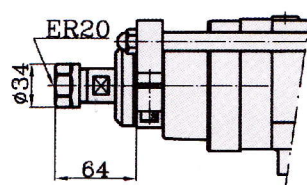

**FD6-130-MT2**

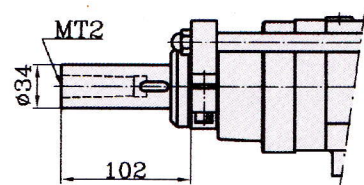

**FD6-130-MT3**

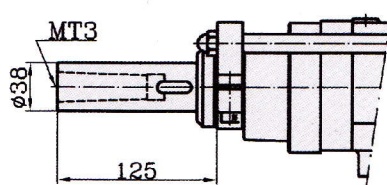

**FD6-130-AS22**

